

# W8CHENGTAI

江阴市诚泰金属制品有限公司

高档铜制锁芯 智造商

HIGH-GRADE COPPER LOCK CYLINDER  
INTELLIGENT MANUFACTURER



[www.hf-copper.com](http://www.hf-copper.com)

江阴市诚泰金属制品有限公司  
JIANGYIN CHENGTAI METAL PRODUCTS CO., LTD.

地址:中国·江苏·江阴市·华士镇·华盛路178号  
Add:No. 178, Huasheng Road, Huashi Town, Jiangyin City, Jiangsu Province, China

电话:0510-86210883	Tel:0510-86210883
传真:0510-86210880	Fax:0510-86210880
邮箱:info@copper.com	Box:info@copper.com
邮编:214421	P.C.:214421
手机:13901521932 15961652713	Mob:13901521932 15961652713

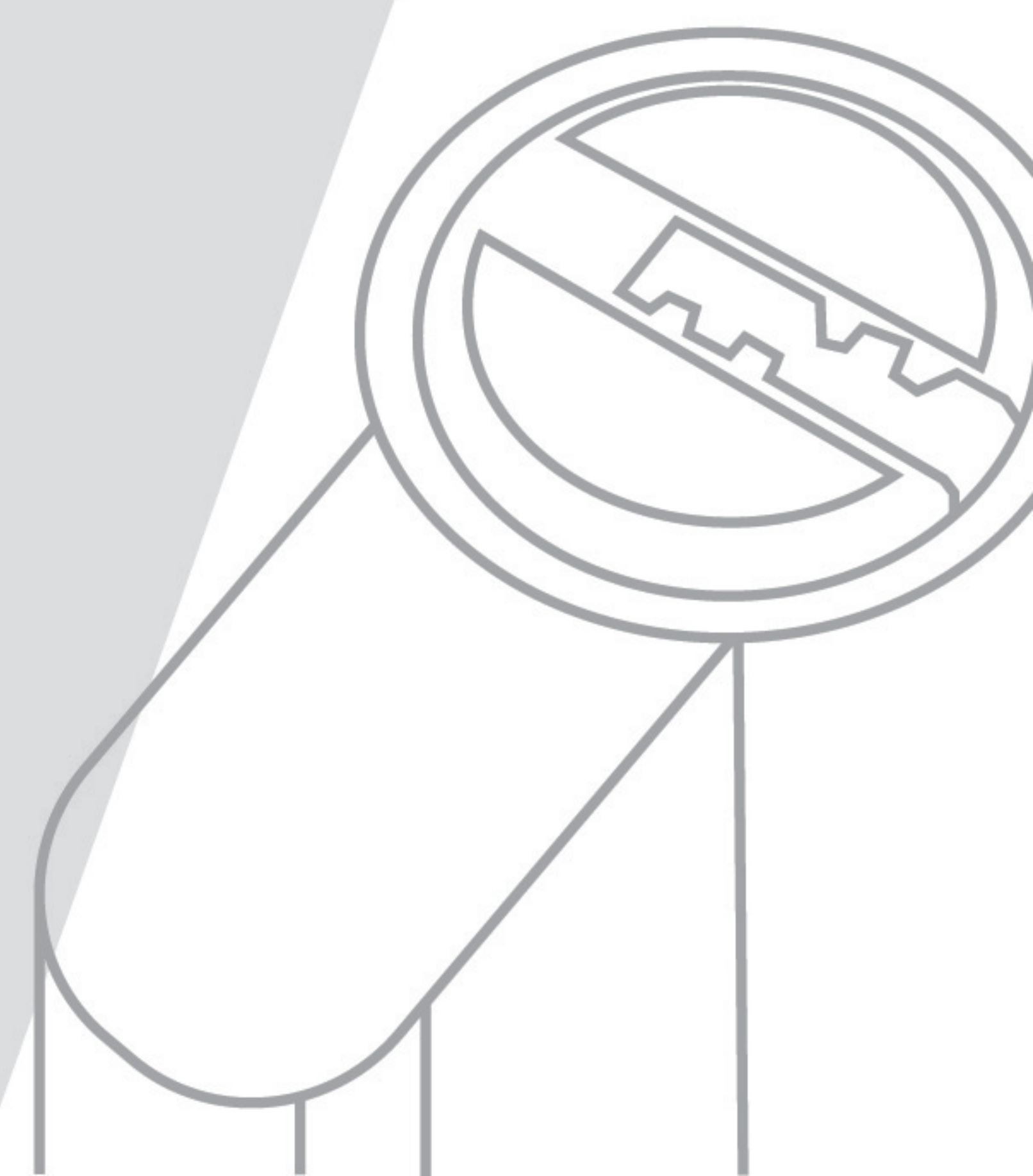

# 目录 | CONTENTS

公司简介 COMPANY PROFILE	01
资质荣誉 QUALIFICATIONS AND HONORS	02
生产实力 PRODUCTION STRENGTH	03
诚泰制造 MADE IN CHENGTAI	05
HF-10坑锁芯系列 HF-10 PROFIL	06
双开锁芯 DOUBLE CYLINDER	07
单开锁芯 THUMBTURN CYLINDER	08
标准锁芯 STANDARD CYLINDER	09
电脑锁芯 COMPUTER CYLINDER	10
椭圆形锁芯 OVAL CYLINDER	10
结构示意图 STRUCTURE DIAGRAM	11
各色标准锁芯 ASSORTED STANDARD CYLINDER	14
绿色环保系列 THE GREEN SERIES	16

## COMPANY PROFILE

### 公司简介

江阴市诚泰金属制品有限公司位于全国百强乡镇、江南名镇--华士镇",东临中国阳光集团,西临中国第一村-华西村。这里青山巍巍、绿水环绕、环境优美、气候宜人。

公司十八年来一直是电解铜、黄铜、磷铜等系列产品的专业生产厂家。产品有各类锁芯、铜棒、各类铜锁芯型材。在不断加强产品质量保证体系的基础上,形成了原材料从国际市场采购到成品严格检验把关出厂的全面质量管理体系。

因此,产品质量不断提高,销售范围不断扩大,现已覆盖了全国20多个省市、自治区、特别是在长三角苏锡常地区有较好的市场占有率。特别是近年来公司引进制锁行业的高精专设备,引进专业技术人才,生产的各类高档黄铜锁芯已得到用户的一致好评!公司锁芯原材料由国外进口,产品主要出口到欧美国家。

我公司设备先进,技术力量雄厚,产品质量可靠,交货迅速,价格合理,热忱欢迎中外客商来人来函垂询洽谈业务。

Jiangyin Chengtai Metal Products Co., Ltd. is located in the top 100 villages and towns in China Huashi Town, a famous town in Jiangnan ", China Sunshine Group in the east, and Huaxi Village, the first village in China, in the west. Here, there are towering green mountains, surrounded by green water, beautiful environment, and pleasant climate.

The company has been a professional manufacturer of electrolytic copper, brass, phosphorous copper and other series of products for 18 years. The products include all kinds of lock cores, copper bars, and various types of copper lock core profiles. On the basis of constantly strengthening the product quality assurance system, the company has formed a strict inspection of raw materials purchased from the international market to finished products Close the factory's total quality management system.

Therefore, the product quality has been continuously improved and the sales scope has been continuously expanded. It has now covered more than 20 provinces and municipalities, autonomous regions, and has a good market share, especially in the Jiangsu, Wuxi and Changzhou regions of the Yangtze River Delta. In particular, in recent years, the company has introduced advanced and specialized equipment in the lock industry, and introduced professional and technical personnel. The various high-grade brass lock cylinders produced by the company have been unanimously praised by users! The lock core raw materials of the company are imported from abroad, and the products are mainly exported to European and American countries.

Our company has advanced equipment, strong technical force, reliable product quality, rapid delivery, and reasonable price. We warmly welcome Chinese and foreign businessmen to write to us for business negotiation.



## QUALIFICATIONS AND HONORS

### 资质荣誉

建立卓有成效的品牌建设之路,使公司发展更具规范性,广阔性。是品质、细节、认真、坚持让品牌更具活力;是标准、责任、荣誉和使命鞭策我们承载过去,开创未来!

Establish an effective brand building road to make the development of the company more normative and broad. It is quality, detail, seriousness and persistence that make the brand more dynamic: it is standards, responsibilities, honor and mission that urge us to carry the past and create the future!



## PRODUCTION STRENGTH

### 生产实力

产品的质量决定企业的成就,从企业诞生起,诚泰便致力于产品品质的不断提升,秉持“品质好、效率高、不断改善”的品质政策,不断更新和完善制造设备和技术,确保客户的品质信心。

公司拥有现代化的厂房及先进的生产设备,高素质的管理人员和高技艺的技术人员,先进的管理模式及营销理念,丰富的生产设计经验。构筑成一个集生产、销售、服务于一体的干练团队。先进的硬件设施和科学的现代化管理,为产品的品质提供了强有力的保障。

The quality of products determines the achievements of enterprises. Since the birth of the enterprise, Chengtai has been committed to the continuous improvement of product quality, adhering to the quality policy of "good quality, high efficiency and continuous improvement, constantly updating and improving manufacturing equipment and technology, and ensuring the quality confidence of customers. The company has modern factory buildings and advanced production equipment, high-quality managers and skilled technicians, advanced management models and marketing concepts, and rich production and design experience. Build a capable team integrating production, sales and service. Advanced hardware facilities and scientific modern management provide a strong guarantee for product quality.





锁壳加工中心设备  
LOCK CASE PROCESSING CENTER EQUIPMENT



锁芯自动下料机  
LOCK CYLINDER AUTOMATIC BLANKING MACHINE



手柄加工中心  
HANDLE MACHINING CENTER



锁芯打孔机  
LOCK CYLINDER PUNCH



组合一体装配机  
INTEGRATED ASSEMBLY MACHINE



检验区  
INSPECTION AREA

## MADE IN CHENGTAI 诚泰制造

每一件产品,每一套独特的工艺,都凝结了我们精益求精的精神。我们深深懂得,只有近乎完美的产品品质,才能始终如一地保证您的利益和价值,才是我们一直的追求。逐步实现制造的高端五化:制造管理的数据化、制造技术的智能化、制造工艺的少人化、产品研发的模块化,质量管理的全员化。

Every product, every set of unique technology, has condensed our spirit of excellence. We deeply understand that only the nearly perfect product quality can consistently guarantee your interests and values, which is our constant pursuit. We will gradually realize the five high-end manufacturing technologies: the digitalization of manufacturing management, the intellectualization of manufacturing technology, the understatement of manufacturing technology, the modularization of product research and development, and the full staff of quality management.



单开锁芯  
THUMBTURN CYLINDER

双开锁芯  
DOUBLE CYLINDER

普通圆头锁芯  
COMMON RIM CYLINDER

## HF-10 PROFIL HF-10坑锁芯系列

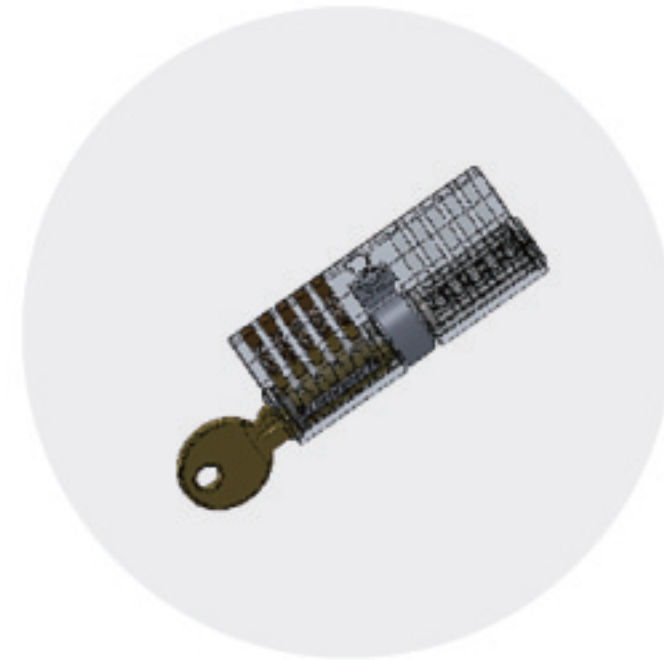
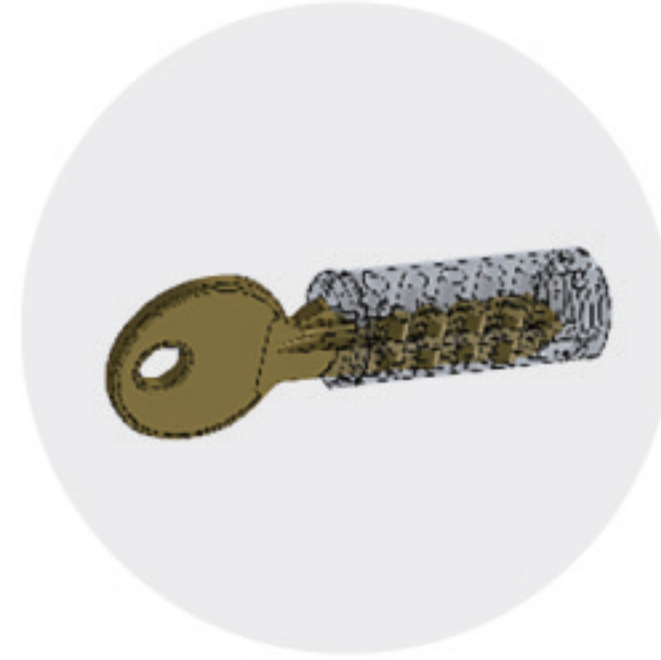
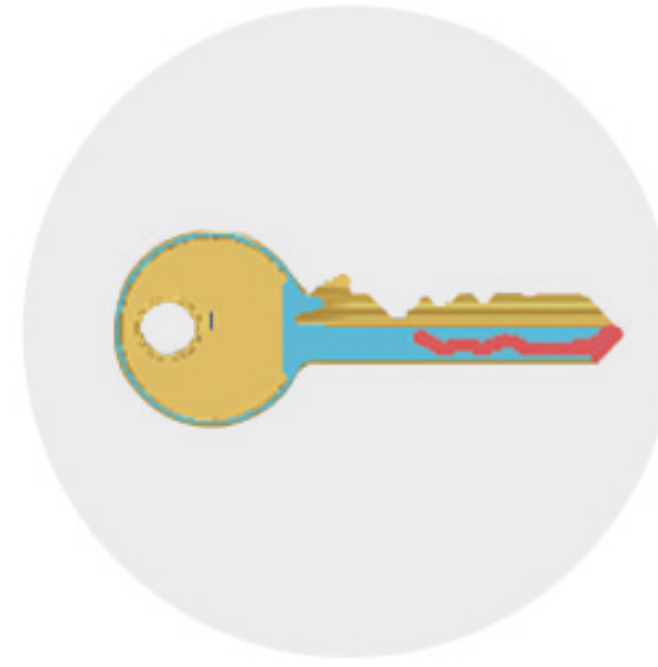

本产品各个部位均由304不锈钢制成，表面美观清洁光亮长久耐用无刮痕永不生锈、永不断裂。其S槽形设计特别，加工难度高。内部采用一排主弹子加一排侧面弹子相结合，这使得市面的其他产品无法复制。产品还具有防挑拨防钻功能，可做MASTERKEY及AB工程钥匙。可应用于插芯锁、铜头锁、外牙锁等。

All parts of this product are made of 304 stainless steel, the surface is beautiful, clean, bright, durable, scratch free, never rust, never break. Its S groove design is special and its processing is difficult. The interior uses a combination of a row of main marbles and a row of side marbles, which makes it impossible for other products on the market to copy. The product also has the function of anti-provocation and anti-drilling, which can be used as MASTERKEY and AB engineering keys. It can be applied to plunger lock, copper head lock, external tooth lock, etc.

## DOUBLE CYLINDER 双开锁芯

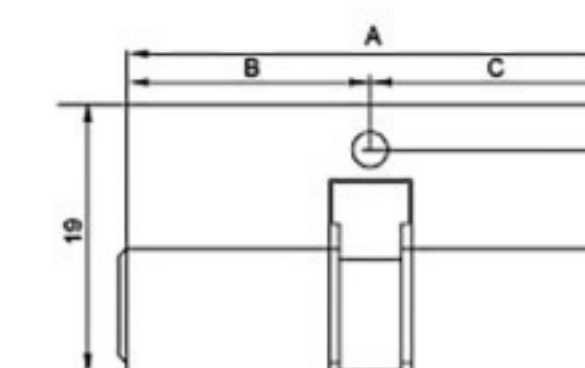
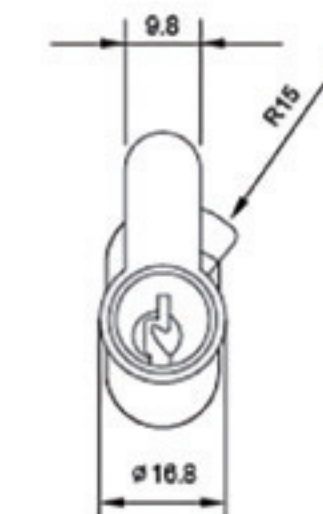

尺寸 DIMENSIONS(mm)			包装说明 (Packing)		
A	B	C			
54	27	27	1	10	10
60	30	30	1	10	10
62	31	31	1	10	10
63	31.5	31.5	1	10	10
68	34	34	1	10	10
68	31	37	1	10	10
70	35	35	1	10	10
70	30	40	1	10	10
80	40	40	1	10	10
80	35	45	1	10	10
90	45	45	1	10	10
90	40	50	1	10	10
100	50	50	1	-	10
100	45	55	1	-	10

## THUMBTURN CYLINDER 单开锁芯

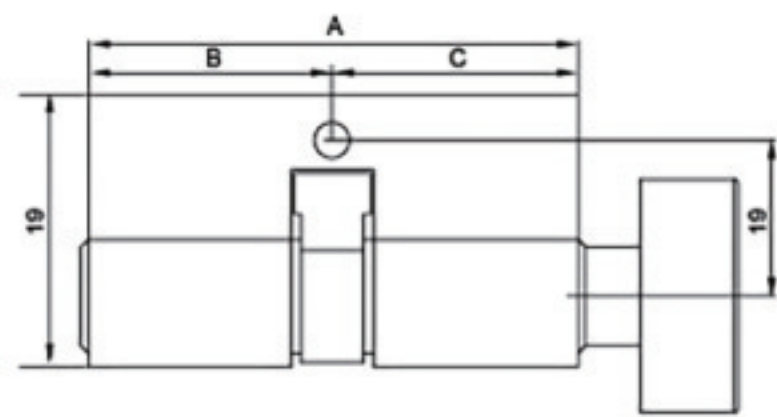
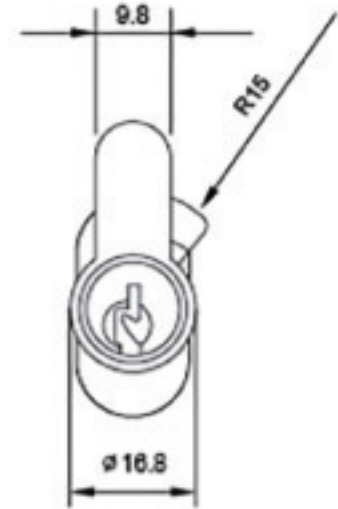
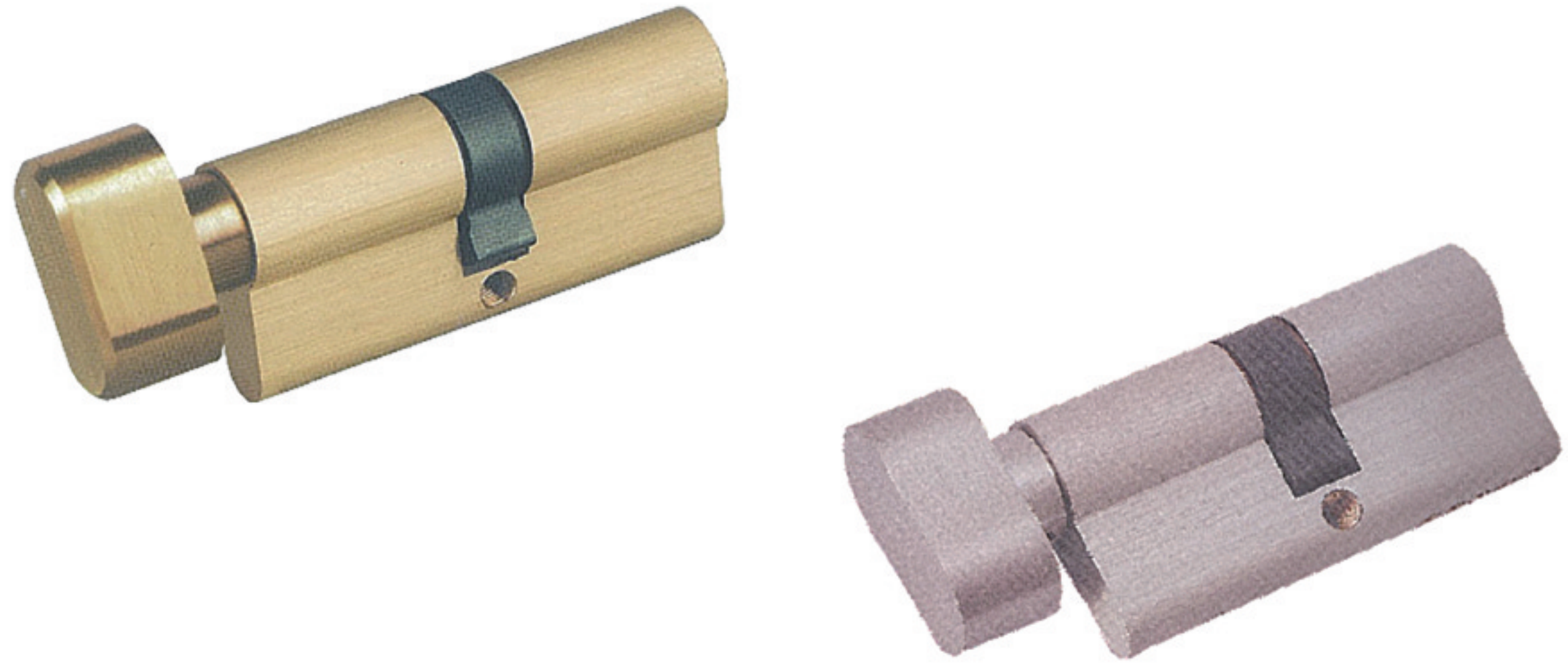

尺寸 DIMENSIONS(mm)			包装说明 (Packing)		
A	B	C			
54	27	27	1	10	10
60	30	30	1	10	10
62	31	31	1	10	10
63	31.5	31.5	1	10	10
68	34	34	1	10	10
68	31	37	1	10	10
70	35	35	1	10	10
70	30	40	1	10	10
80	40	40	1	10	10
80	35	45	1	10	10
90	45	45	1	10	10
90	40	50	1	10	10
100	50	50	1	-	10
100	45	55	1	-	10

## STANDARD CYLINDER 标准锁芯

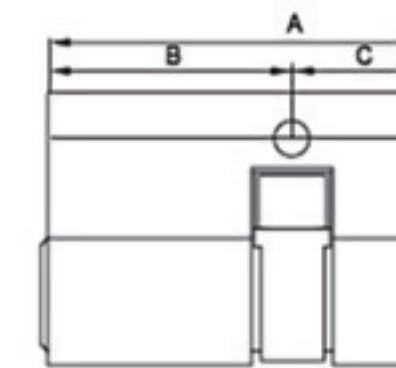

尺寸 DIMENSIONS(mm)			包装说明 (Packing)		
A	B	C			
54	27	27	1	10	10
60	30	30	1	10	10
62	31	31	1	10	10
63	31.5	31.5	1	10	10
68	34	34	1	10	10
68	31	37	1	10	10
70	35	35	1	10	10
70	30	40	1	10	10
80	40	40	1	10	10
80	35	45	1	10	10
90	45	45	1	10	10
90	40	50	1	10	10
100	50	50	1	-	10
100	45	55	1	-	10

## COMPUTER CYLINDER 电脑锁芯

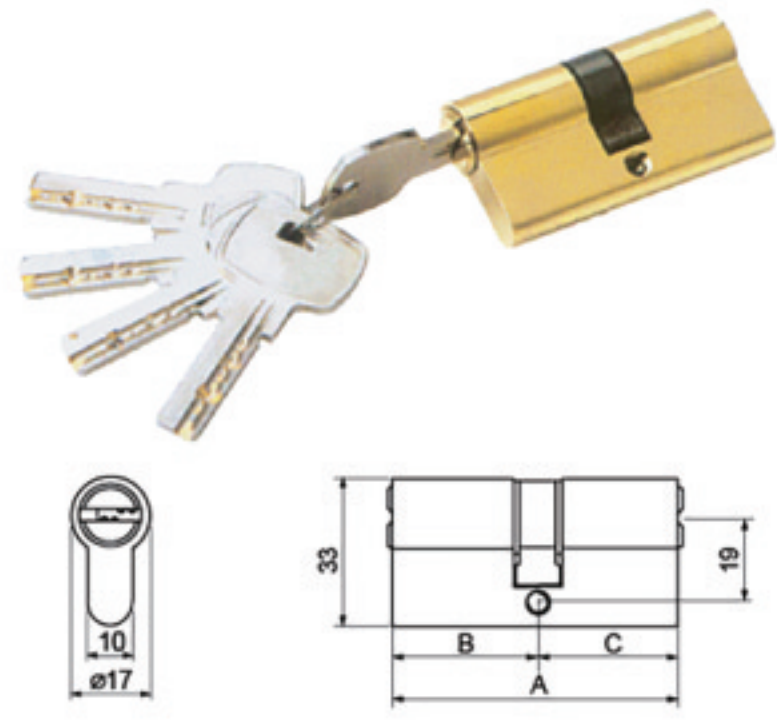

尺寸 DIMENSIONS(mm)			包装说明 (Packing)		
A	B	C			
60	30	30	1	10	10
62	31	31	1	10	10
63	31.5	31.5	1	10	10
68	31	31	1	10	10
70	35	35	1	10	10
80	40	40	1	10	10
90	45	45	1	10	10
100	50	50	1	10	10

## OVAL CYLINDER 椭圆形锁芯



尺寸 DIMENSIONS(mm)			包装说明 (Packing)		
A	B	C			
54	27	27	1	10	10
55	27.5	27.5	1	10	10
60	30	30	1	10	10
65	32.5	32.5	1	10	10

## STRUCTURE DIAGRAM 结构示意图

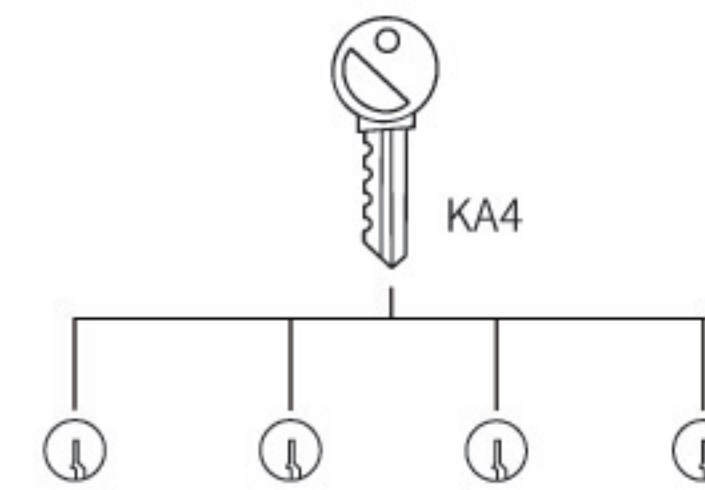
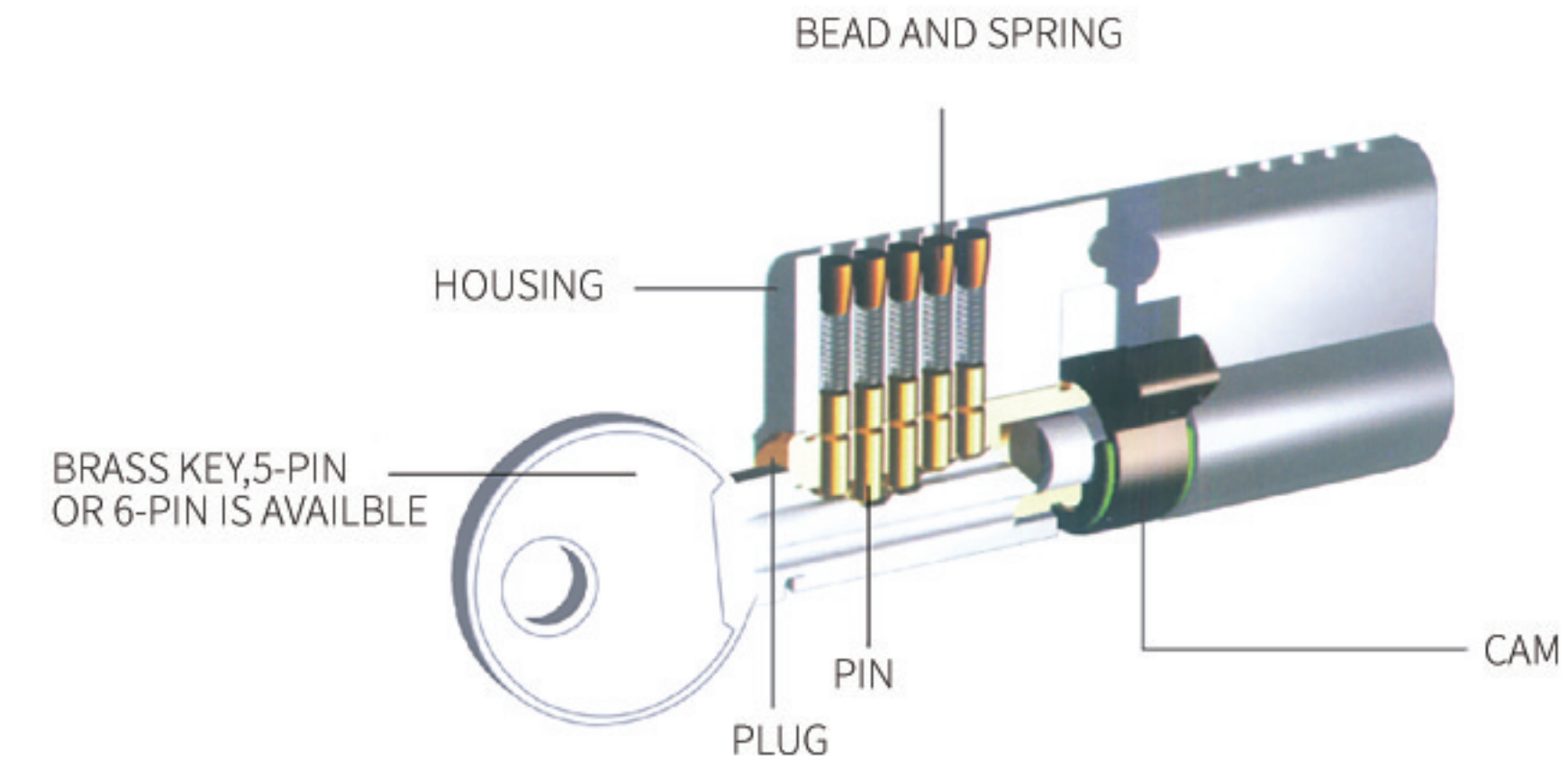



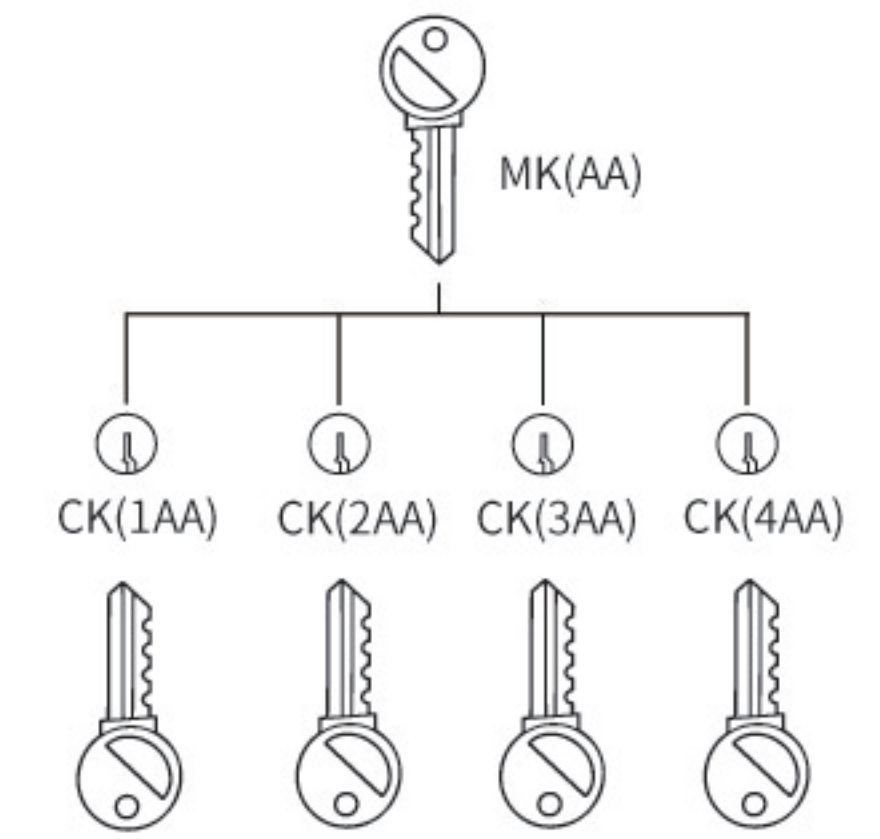



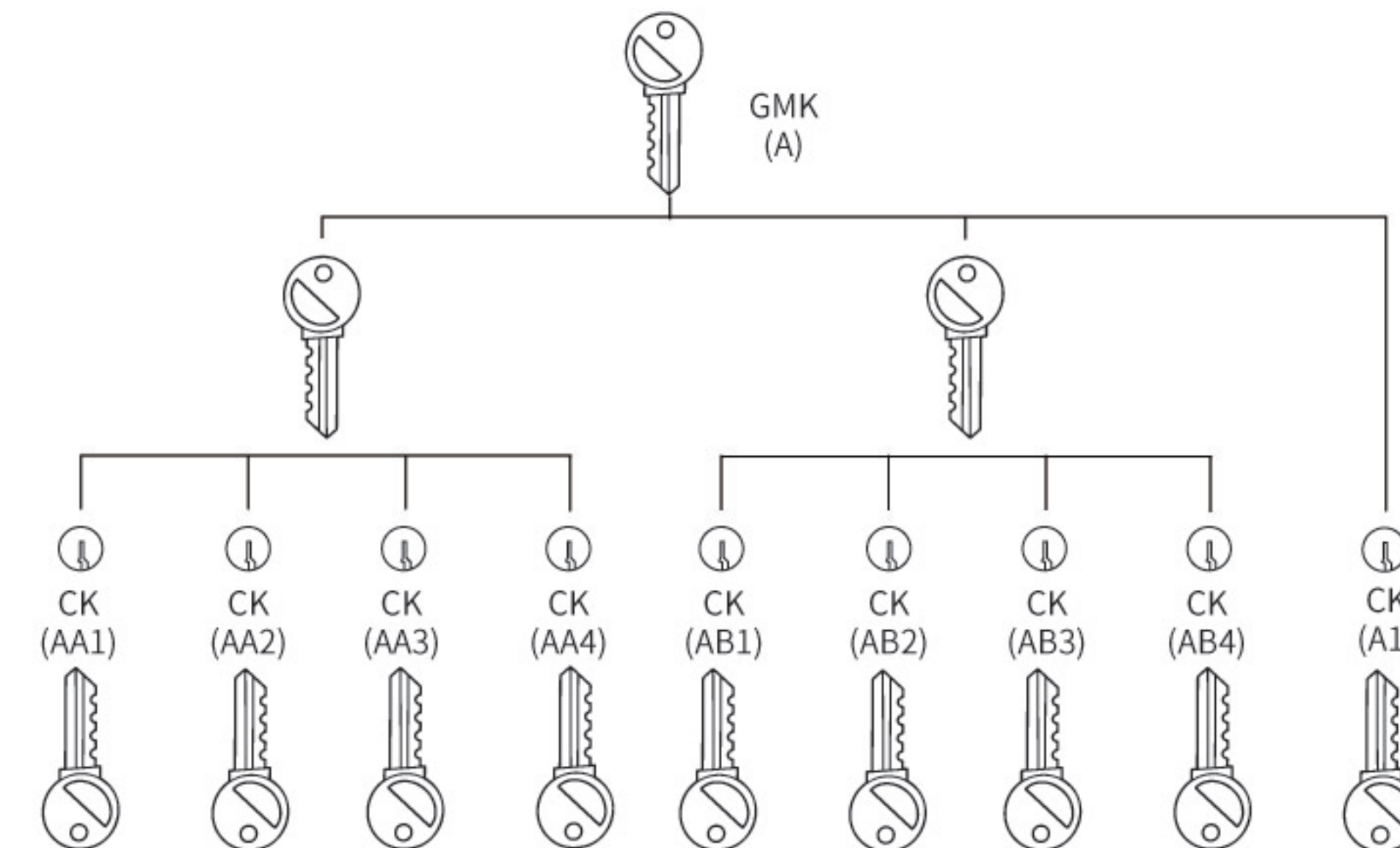

同号锁示意图  
SCHEMATIC DIAGRAM OF LOCK WITH THE SAME NUMBER

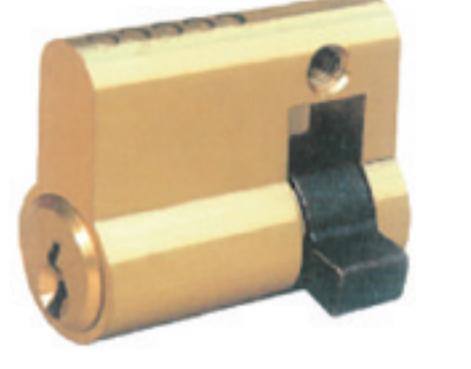

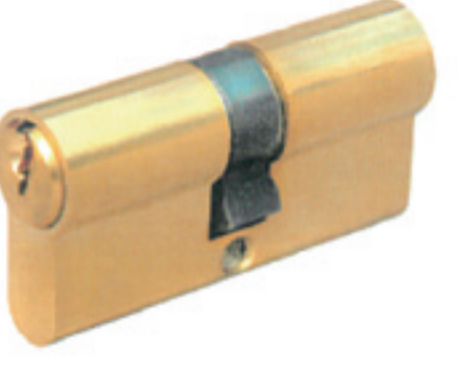
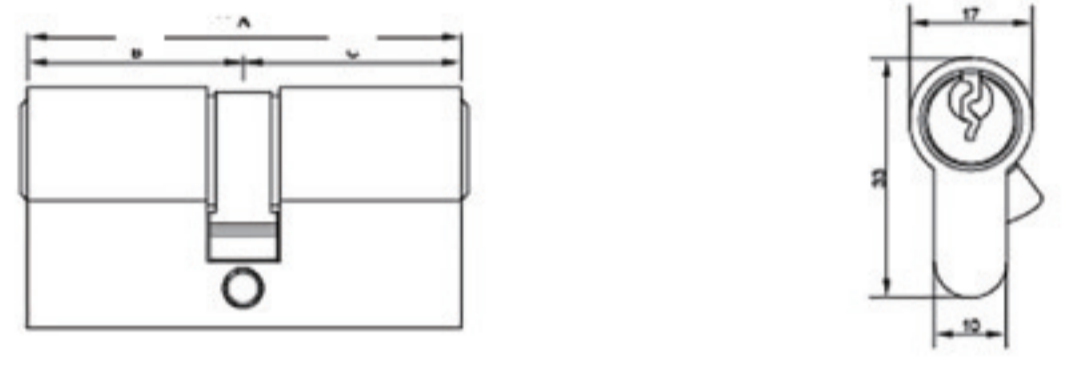

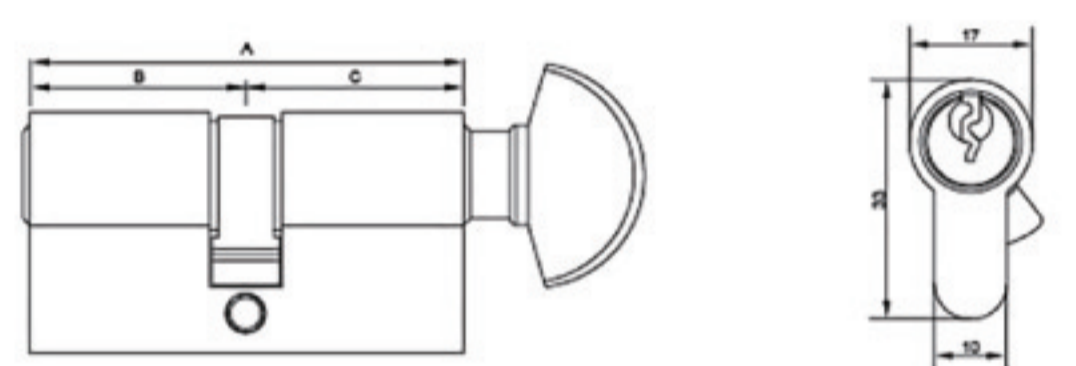
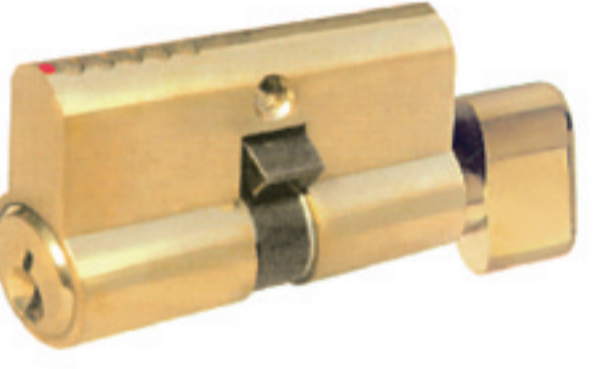
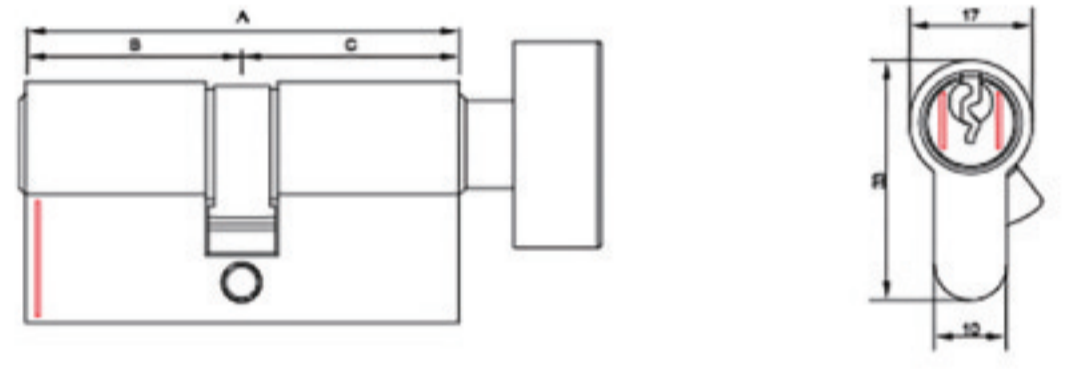
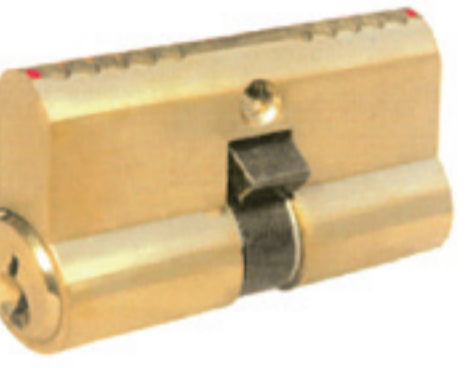

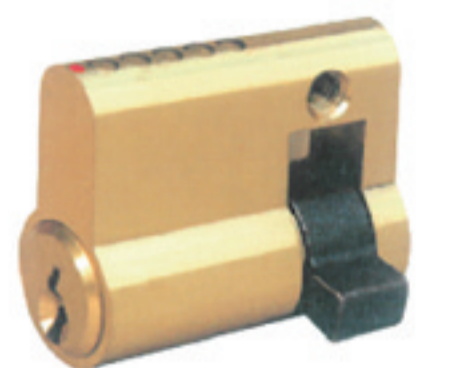



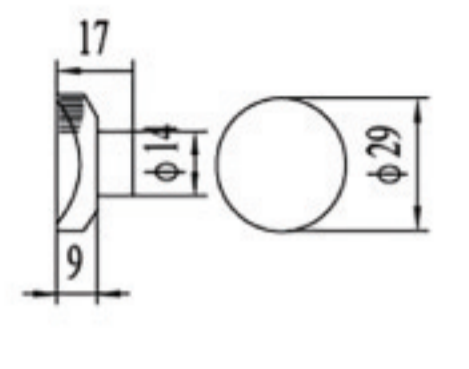

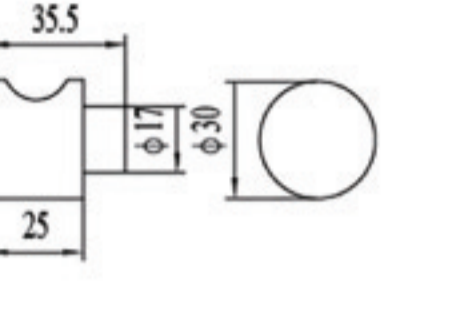

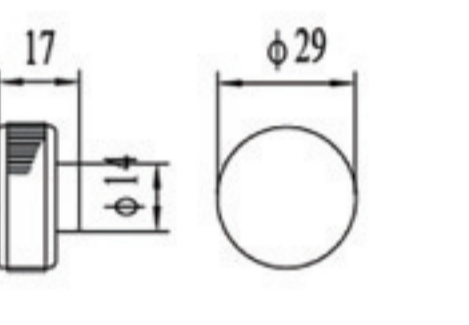

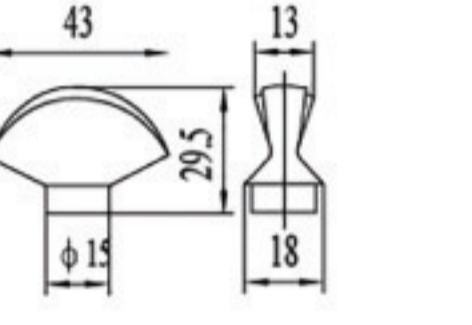

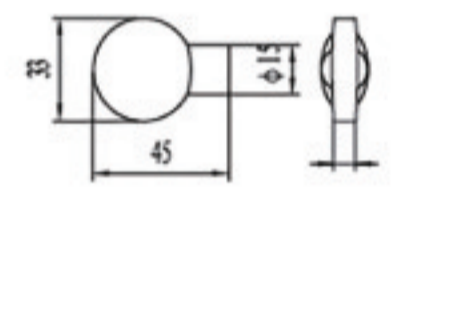

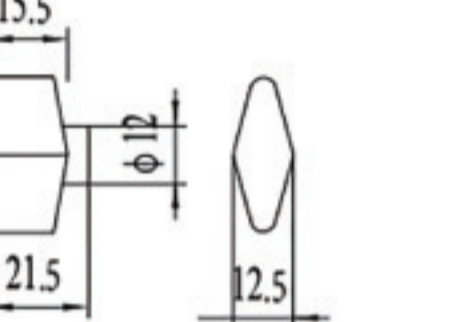

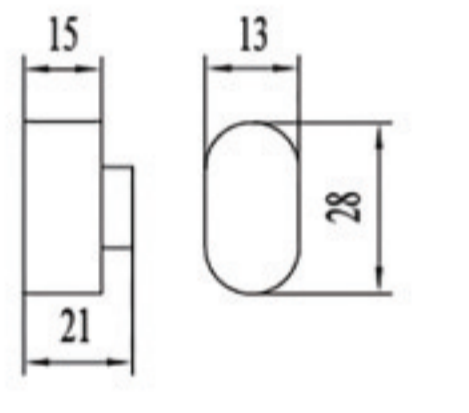

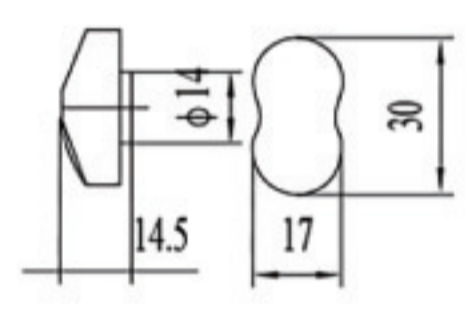
二级管理锁系统示意图  
SCHEMATIC DIAGRAM OF SECONDARY MANAGEMENT LOCK SYSTEM

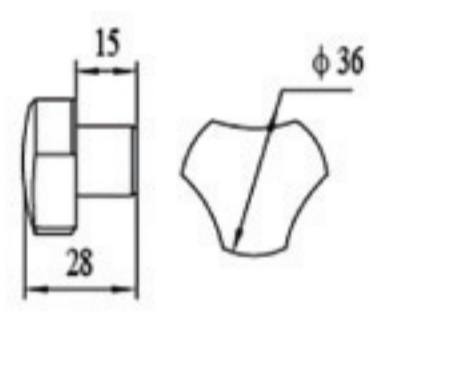

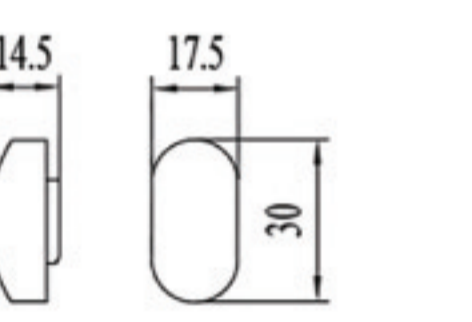
三级管理锁系统示意图  
SCHEMATIC DIAGRAM OF THREE-LEVEL MANAGEMENT LOCK SYSTEM

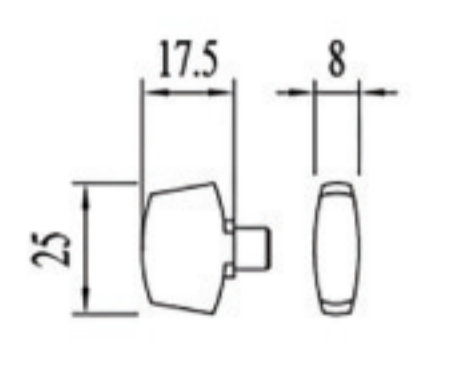
功能锁芯 FYBCTUB CYLINDER	单边		
	双开		
	单开		
特殊安全2根防钻针锁芯 W/2 PCS ANTI-DRILL PINS	单开		
	双开		
	单边		

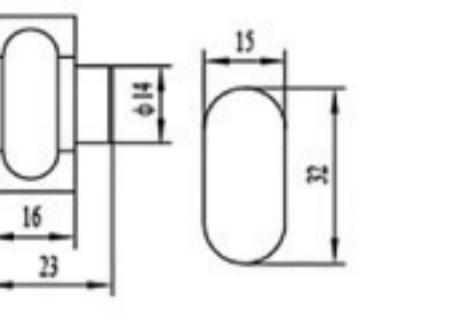
<b>K00</b>			<b>K01</b>		
<b>K02</b>			<b>K03</b>		
<b>K04</b>			<b>K05</b>		
<b>K06</b>			<b>K07</b>		
<b>K08</b>			<b>K09</b>		
<b>K10</b>			<b>K11</b>		



## ASSORTED STANDARD CYLINDER 各色标准锁芯



青古铜 AB  
ANTIQUÉ BRASS



抛光 PB  
POLISHED BRASS



红古铜 AC  
ANTIQUÉ COPPER



镀铬 CP  
CHROME PLATED



黑镍 BN  
BLACK NICKEL



镀镍 NP  
NICKEL PLATED



不锈钢 SS  
STAINLESS STEEL



铜研磨 SB  
SANDY BRASS



镍拉丝 NB  
NICKEL BRUSHED



珍珠镍 PNP  
PEARL NICKAL PLATED



哑光黑 MB  
MATTE BLACK

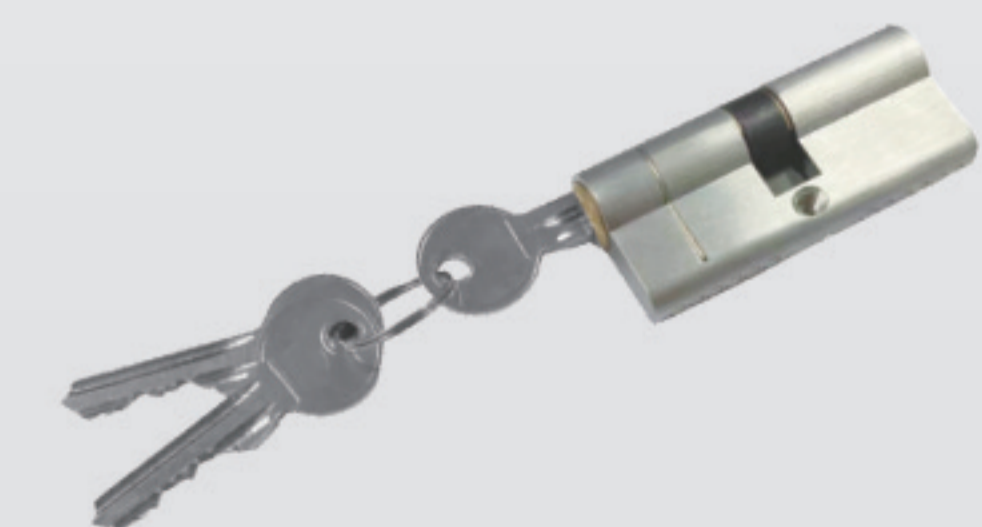

拉丝铬 SC  
SILK CHROME

## THE GREEN SERIES 绿色环保系列



**Cylinder body:** unique appearance design, standard specifications, MS58BRASS

**Key:** dimple standard with nickel plated

**Cam:** sintered steel(HRB40-60)

**Spring:** phosphor bronze,(Cu37,Sn8) stainless steel(inox)

**Beads:** MS58 type or anti drill steel beads HRC60



**Cylinder body:** unique appearance design, standard specifications, MS58BRASS or satin nickel plated

**Key:** dimple standard with nickel plated

**Cam:** sintered steel(HRB40-60)

**Spring:** phosphor bronze,(Cu37,Sn8) stainless steel(inox)

**Beads:** MS58 type or anti drill steel beads HRC60

**Precision key combination:** numerical control technology



**Cylinder body:** unique appearance design, standard specifications, MS58BRASS or satin nickel plated

**Key:** dimple standard with nickel plated

**Cam:** sintered steel(HRB40-60)

**Spring:** phosphor bronze,(Cu37,Sn8) stainless steel(inox)

**Beads:** MS58 type

**Precision key combination:** numerical-control technology

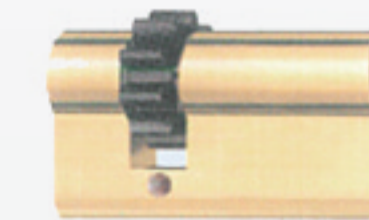

**Cylinder body:** unique appearance design, standard specifications, MS58BRASS or stain nickel plated

**Key:** dimple standard with nickel plated

**Cam:** sintered steel

**Z:** ten gears

**Beads:** MS58 type or anti drill steel beads HRC60

**Precision key combination:** numerical-control technology

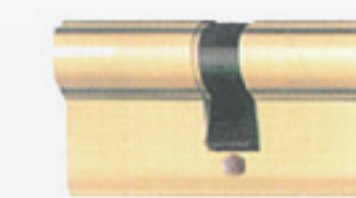

**Cylinder body:** unique appearance design, standard specifications, MS58BRASS or stain nickel plated

**Key:** dimple standard with nickel plated

**Cam:** sintered steel(HRB40-60)

**Spring:** phosphor bronze,(Cu37,Sn8) stainless steel(inox)

**Beads:** MS58 type

**Cylinder housing:** with steel screw

**Cylinder pin:** anti-inserting each side

**Precision key combination:** numerical-control technology

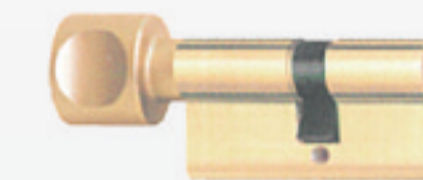

**Cylinder body:** unique appearance design, standard specifications, MS58BRASS or stain nickel plated

**Key:** dimple standard with nickel plated

**Cam:** sintered steel(HRB40-60)

**Spring:** phosphor bronze,(Cu37,Sn8) stainless steel(inox)

**Beads:** MS58 type

**Cylinder housing:** with steel screw

**Cylinder pin:** anti-inserting each side

**Precision key combination:** numerical-control technology

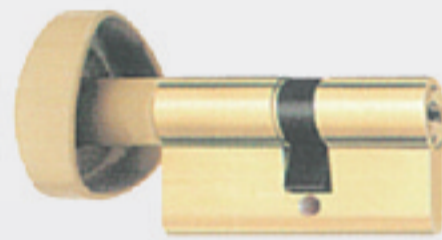

**Cylinder body:** unique appearance design, standard specifications, MS58BRASS or satin nickel plated

**Key:** dimple standard with nickel plated

**Cam:** sintered steel(HRB40-60)

**Spring:** phosphor bronze,(Cu37,Sn8) stainless steel(inox)

**Beads:** MS58 type or anti drill steel beads HRC60

**Knob:** zinc alloy

**Precision key combination:** numerical control technology

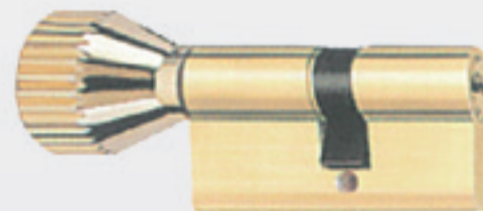

**Cylinder body:** unique appearance design, standard specifications, MS58BRASS or satin nickel plated

**Key:** dimple standard with nickel plated

**Cam:** sintered steel(HRB40-60)

**Spring:** phosphor bronze,(Cu37,Sn8) stainless steel(inox)

**Beads:** MS58 type or anti drill steel beads HRC60

**Knob:** special plastic or copper

**Precision key combination:** numerical control technology

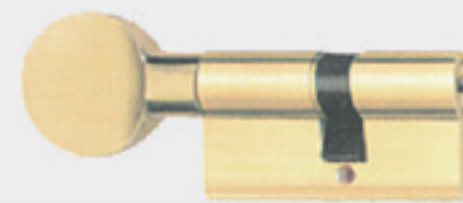

**Cylinder body:** unique appearance design, standard specifications, MS58BRASS or satin nickel plated

**Key:** dimple standard with nickel plated

**Cam:** sintered steel(HRB40-60)

**Spring:** phosphor bronze,(Cu37,Sn8) stainless steel(inox)

**Beads:** MS58 type or anti drill steel beads HRC60

**Knob:** zinc alloy or copper

**Precision key combination:** numerical control technology

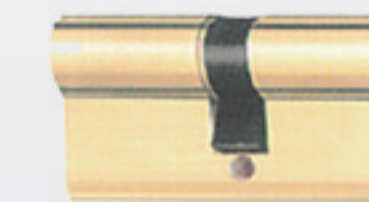

**Cylinder body:** unique appearance design, standard specifications, MS58BRASS or stain nickel plated

**Key:** dimple standard with nickel plated

**Cam:** sintered steel(HRB40-60)

**Spring:** phosphor bronze,(Cu37,Sn8) stainless steel(inox)

**Beads:** MS58 copper type or anti drill steel beads HRC60

**Precision key combination:** numerical-control technology

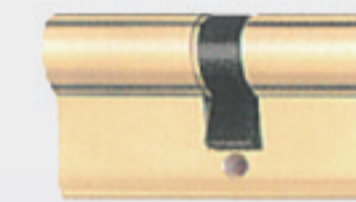

**Cylinder body:** unique appearance design, standard specifications, MS58BRASS or aluminum plated, stain nickel plated

**Key:** dimple standard with nickel plated

**Cam:** sintered steel(HRB40-60)

**Spring:** phosphor bronze,(Cu37,Sn8) stainless steel(inox)

**Beads:** MS58 copper type

**Precision key combination:** numerical-control technology



**Cylinder body:** unique appearance design, standard specifications, MS58BRASS or stain nickel plated

**Key:** dimple standard with nickel plated

**Cam:** sintered steel(HRB40-60)

**Spring:** phosphor bronze,(Cu37,Sn8)

**Beads:** MS58 type or anti drill steel beads HRC60

**Security beads:** with anti-drawing beads in type

**Precision key combination:** numerical control technology



**Cylinder body:** unique appearance design, standard specifications, MS58BRASS or satin nickel plated

**Key:** dimple standard with nickel plated

**Cam:** sintered steel(HRB40-60)

**Spring:** phosphor bronze,(Cu37,Sn8) stainless steel(inox)

**Beads:** MS58 copper type or anti drill steel beads HRC60

**Precision key combination:** numerical control technology



**Cylinder body:** unique appearance design, standard specifications, MS58BRASS or satin nickel plated

**Key:** dimple standard with nickel plated

**Cam:** sintered steel(HRB40-60)

**Spring:** phosphor bronze,(Cu37,Sn8) stainless steel(inox)

**Beads:** MS58 copper type or anti drill steel beads HRC60

**Precision key combination:** numerical control technology



**Cylinder body:** unique appearance design, standard specifications, MS58BRASS or satin nickel plated

**Key:** dimple standard with nickel plated

**Cam:** sintered steel(HRB40-60). Eight points to control.

**Spring:** phosphor bronze,(Cu37,Sn8) stainless steel(inox)

**Beads:** MS58 copper type or anti drill steel beads HRC60

**Precision key combination:** numerical control technology



**Cylinder body:** unique appearance design, standard specifications, MS58BRASS or stain nickel plated

**Key:** dimple standard with nickel plated

**Cam:** sintered steel(HRB40-60)

**Spring:** phosphor bronze,(Cu37,Sn8) stainless steel(inox)



**Beads:** MS58 type or anti drill steel beads HRC60. With two patent anti-knocking beads

**Security beads:** with anti-drawing beads in type

**Precision key combination:** numerical-control technology



The 1640BS series of lock cylinders. with the auto function of closing, provide the superior safety guarantee for anti-destructive. If any picklock, except the original key, inserts the cylinder, its channel will be closed by the special safety beads, which eradicates the possibility of non-security inserting.